

ACHTUNG: Diese Zeichnung ist geistiges Eigentum der Firma GIFAS-ELECTRIC und darf daher weder vervielfältigt noch Dritten zugänglich gemacht werden.

ATTENTION: Ce dessin est propriété de l'entreprise GIFAS-ELECTRIC et ne doit ni être copié ni remis à des tiers.

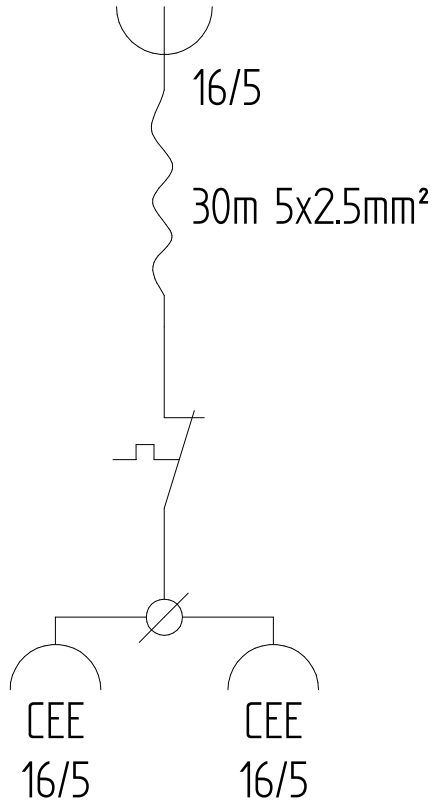
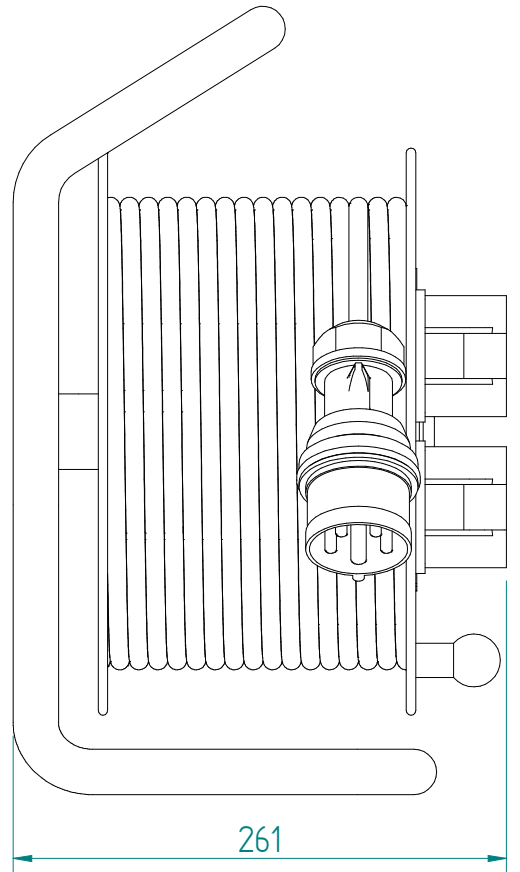
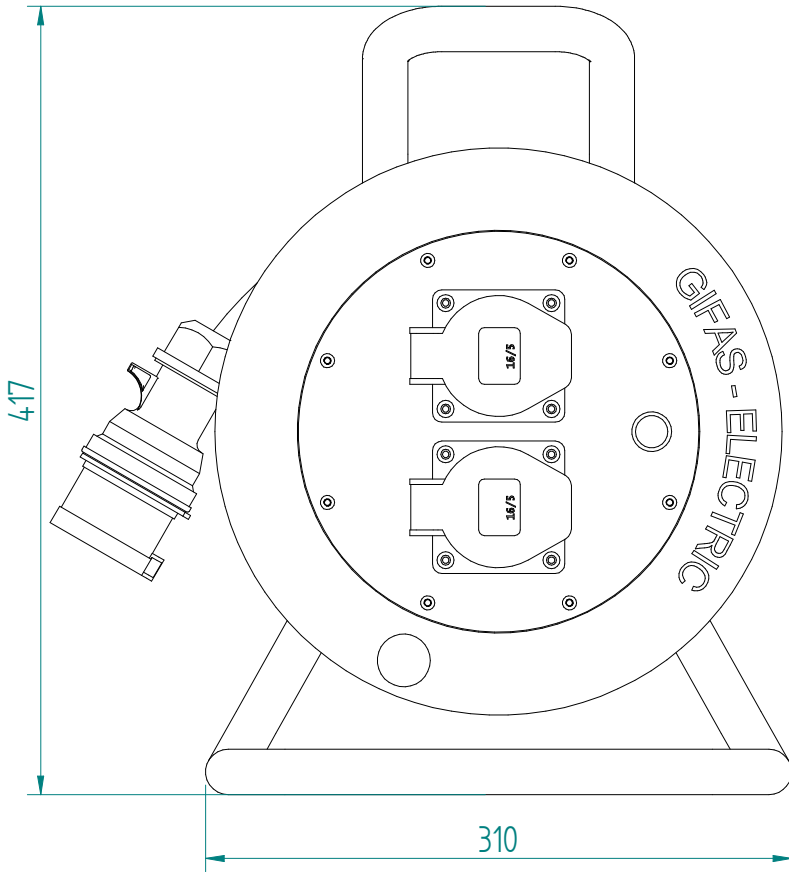

ATTENTION: Il presente disegno è di proprietà della ditta GIFAS ELECTRIC. Riproduzione vietata.  
ATTENTION: This design is property of GIFAS-ELECTRIC GmbH and may not be copied or distributed among unauthorized persons.

**GIFAS**  
ELECTRIC

GIFAS-ELECTRIC GmbH  
Dietrichstrasse 2 - CH-9424 Rheineck  
☎ +41 71 886 44 44 ✉ info@gifas.ch  
📠 +41 71 886 44 44 🌐 www.gifas.ch

**Kabelrolle**  
**KR 502**

Art.-Nr. : **092886**

25.02.2022

Blatt 1/1  
phwa